

New



# DPSENSE-V

Multi-Range Air Velocity Transmitter  
User Manual



**ABUS TECHNOLOGIES INC.**

## WARNING

---

- ✓ This manual should be passed on to the end user.
- ✓ The contents of this manual are subject to change without prior notice.
- ✓ All rights reserved.
- ✓ ABUS gives no warranty of any kind with regard to this manual, including, but not limited to, fitness for a particular purpose.
- ✓ If any question arises or errors are found, or if any information is missing from this manual, please inform your supplier or inform at [info@abustek.com](mailto:info@abustek.com).
- ✓ The specifications mentioned in this manual are limited to those for the standard type under the specified model number break-down and do not necessarily apply for customized instruments.
- ✓ Please note that changes in the specifications, construction, or component parts of the instrument may not immediately be reflected in this manual at the time of change.
- ✓ If the customer or any third party is harmed by the use of this product, ABUS assumes no responsibility for any such harm owing to any defects in the product which were not predictable, or for any indirect damages.

Although Warning hazards are related to personal injury, and Caution hazards are associated with equipment or property damage, it must be understood that operation of damaged equipment could, under certain operational conditions, result in degraded process system performance leading to personal injury or death. Therefore, comply fully with all Warning and Caution notices.

Information in this manual is intended only to assist our customers in the efficient operation of our equipment. Use of this manual for any other purpose is specifically prohibited and its contents are not to be reproduced in full or part without prior approval of Technical Communications Department, ABUS Technologies

## HEALTH AND SAFETY

---

To ensure that our products are safe and without risk to health, the following points must be noted:

1. The relevant sections of these instructions must be read carefully before proceeding.
2. Warning labels on containers and packages must be observed.
3. Installation, operation, maintenance and servicing must only be carried out by suitably trained personnel and in accordance with the information given. Any deviation from these instructions will transfer the complete liability to the user.
4. Normal safety precautions must be taken to avoid the possibility of an accident occurring when operating in conditions of high pressure and/or temperature.
5. Chemicals must be stored away from heat, protected from temperature extremes and powders kept dry. Normal safe handling procedures must be used.
6. When disposing of chemicals ensure that no two chemicals are mixed.

Safety advice concerning the use of the equipment described in this manual or any relevant hazard data sheets (where applicable) may be obtained from the Company address on the back cover, together with servicing and spares information.

# CATALOGUE

<b>Contents</b>		<b>Page No.</b>
<b>1. Introduction</b>		<b>4</b>
<b>2. Presentation</b>		<b>4</b>
1 Features		4
2 Technical Parameters		4
<b>3. Dimensions</b>		<b>5</b>
<b>4. Ordering details</b>		<b>5</b>
<b>5. Electrical connections</b>		<b>6</b>
1. 2-wire connections		6
2. 3-wire connections		6
<b>6. Installation</b>		<b>7</b>
1 Recommendation		7
2 Mounting		7
3 LCD installation (Optional)		7
<b>7. Configuration</b>		<b>8</b>
Range Selection		8
<b>8. Calibration</b>		<b>9</b>
1 Preparation		9
2 Analogue Zero Calibration		9
3 Analogue Span Calibration		10
4 Filter Time Constant Adjustment		11
5 Coefficient K Adjustment		11
6 Restore Factory Calibration		12
<b>9. Maintenance</b>		<b>12</b>
One Press Reset		12
<b>10. Safety Precautions</b>		<b>13</b>
<b>11. Warranty</b>		<b>13</b>

## 1. INTRODUCTION

The **DPSense-V Series Multi-Range Air Velocity Transmitter** is an extremely versatile transmitter for monitoring pressure and air velocity. This compact package is loaded with features such as: field selectable English or metric ranges, field upgradeable LCD display.

Optional features include adjustable dampening of output signal, K-Factor and the ability to select a square root output for use with Pitot tubes and other similar flow sensors.

Along with these features, the magnetic sensing technology provides exceptional long term performance and enables the DPSense-V transmitter to be the solution for a many of pressure, differential pressure and flow applications.

Note

## 2. PRESENTATION

### 2.1 Features

- 1 Capable of measuring dirty service, insensitive to dust, oil dirt, temperature, and humidity.
- 2 Three selectable ranges for each model, adjustable in field by the user.
- 3 The damp, unit and K coefficient can be adjusted in field.
- 4 Re-zeroed by one key-press, span is adjustable.
- 5 Users are allowed to calibrate according to actual flow.
- 6 Optional LCD display

### 2.2 Technical Parameters

<b>Service:</b>	Air and non-combustible gases, compatible gases
<b>Range:</b>	0-3 m/s ~ 0-40m/s.
<b>Power supply:</b>	10-35 VDC (2-wire); 17-36 VDC or isolated 15-26 VAC (3-wire).
<b>Max. Power Consumption:</b>	40mA.
<b>Output Signal:</b>	4-20mA (2-wire), 0-5V (3-wire); 0-10V (3-wire)
<b>Response time:</b>	0.5-15s continuously, adjustable in field.
<b>Work temperature:</b>	-10 to 50°C.
<b>Loop resistance:</b>	<i>Current output:</i> 0-1250 max. <i>Voltage output:</i> 1000 min. load
<b>Housing material:</b>	ABS plastic.
<b>Display (Optional):</b>	4-digit LCD.
<b>Stability:</b>	±1 %F.S./YR.
<b>K Coefficient Adjustable Range:</b>	0.5 ~ 3.0
<b>Electrical Connections:</b>	4~20mA output, 2-wire continental terminal; 0~10V output, 3-wire continental terminal.
<b>Enclosure rating:</b>	IP65.
<b>Mounting orientation:</b>	Vertical.

### 3. DIMENSIONS

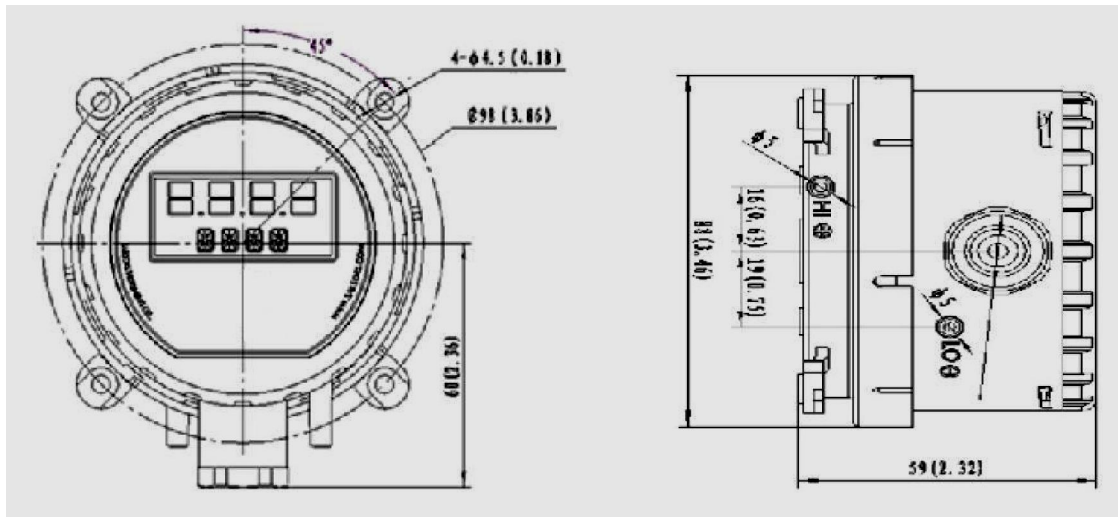

All Dimensions in mm

### 4. ORDERING DETAILS

TYPE			DESCRIPTION	
Product	DPSENSE-V		Multi-Range Air Velocity Transmitter	
Output		A	4~20 mA (2-wire)	
		V1	0~10 V (3-wire)	
		V2	0~5 V (3-wire)	
Accessories		N	None	
		L	LCD	
		F	Air Flow Measuring probe	
Ranges			<b>METRIC</b>	<b>ENGLISH</b>
		01	3 / 6 / 12 m/s	600 / 1200 / 2400 fpm.
		02	8 / 12 / 20 m/s	1600 / 2400 / 4000 fpm.
		03	20 / 30 / 40 m/s	4000 / 6000 / 8000 fpm.

**Example: DPSENSE-V > A > L > 01**

## 5. ELECTRICAL CONNECTIONS

### 5.1 2-Wire Connections

A couple of terminal blocks PWR that connect the transmitter to the power and receiver are located on the bottom of the PCB board. The polarities are signed by “+” and “-”. Make sure that the connections between transmitter, power and receiver are correct according to Fig. below

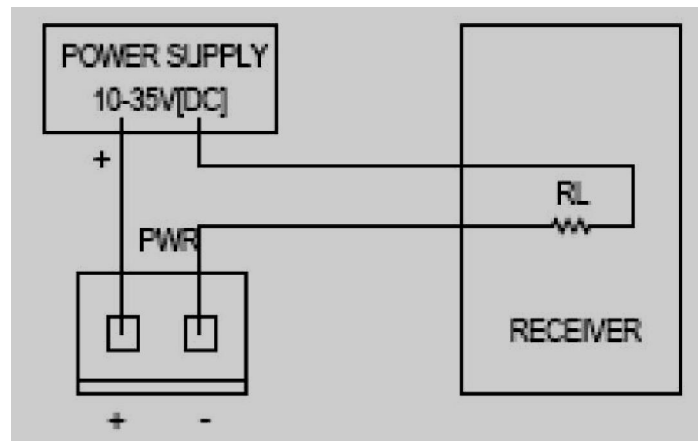

The receiver load resistance (RL) for DDC/PLC/DCS can be got from the formula and graph in fig. below.

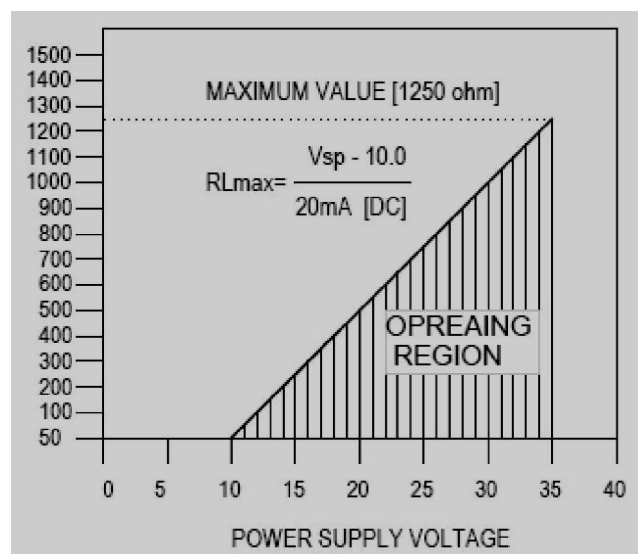

### 5.2 3-Wire Connections

Three terminal blocks PWR that connect the transmitter to the power and receiver are located on the bottom of the PCB board. The polarities are signed by “+” and “-”, and the output as Volt. Make sure that the connections between transmitter, power and receiver are correct according to Fig. below.

The output of Volt on PWR is 0-10 VDC, carrying no higher than 10 mA current and so against no lower than 1 K  $\Omega$  of the receiver load resistance.

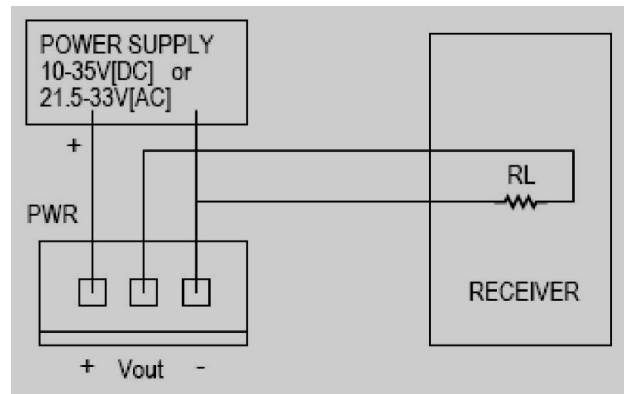

*NOTE: THE VOLTAGE FOR THE POWER MUST NOT BE HIGHER THAN THE RATED ONE, OR THE TRANSMITTER WILL BE DAMAGED FOREVER. THEN THE TRANSMITTER WILL NOT BE PREPARED FOR FREE.*

## 6. INSTALLATION

### 6.1 Recommendation

- Upon receipt please inspect the instrument for the intended application pressure range.
- Install the instrument in a location away from fans, corners, heating and cooling coils and other equipment.
- All standard DPSENSE-V transmitters are calibrated in the vertical position. To maintain the specified accuracy, the transmitters must be mounted in the vertical surface
- Make sure that the pressure ports and the electrical cable connectors are directed down in a vertical position.

### 6.2 Mounting

Secure the transmitter on the vertical mounting surface with 4 provided screws, do not screw down badly. Opening: the cover should be removed before the electrical connections are made. Contrarotate the cover until the ears of the cover have come to the other sides of the holes (observe the four rectangle holes in the house), then remove the cover using fingers.

### 6.3 LCD Installation (Optional)

Any non display DPSENSE-V can get the display function by directly mounting the LCD display on the main PCB board by the connectors CN1 and CN2. The kit contains an LCD display and displacement cover with the LCD window (non display DPSENSE-V has no this window). The optional LCD can display differential pressures (the unit and range displayed in the LCD are corresponding to the relevant setup). After upgraded with the display kit, in case that the display value of the transmitter is different from the analog output because of the incorrect adjustment by the user before upgrading, calibrate the analog output's zero to either 0 V or 4mA, the full scale to either 10V or 20 mA. See the user calibration section for details on how to perform these operations. Most of the sectors below are based on the DPSENSE-V with LCD display.



## 7. CONFIGURATION

### Range Selection

Putting the shorting jumper on a pair of jumper blocks as fig. below can select the ranges.

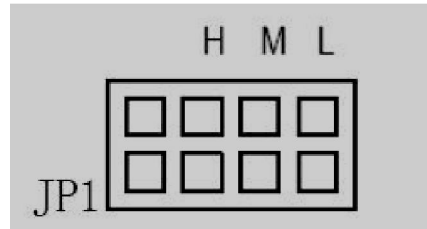

The JP1 jumper switch is designed to select ranges. There are three selectable ranges for each DPSENSE-V transmitter with the H corresponding to high pressure, M to middle pressure and L to low pressure. When the two blocks below H are shorted together by the shorting jumpers, the output of the transmitter is in the highest range, so it is for M and L. The unit is calibrated in the highest range in the factory. No range can be selected without two blocks below H or M or L shorted together. DPSENSE-V can be easily setup in English or metric units. When the two blocks below U are shorted together by the provided jumper shorter, metric unite (m/s) is selected. English unit (ft/min.) can be selected when any couple of blocks in vertical position is shorted except the ones below U.

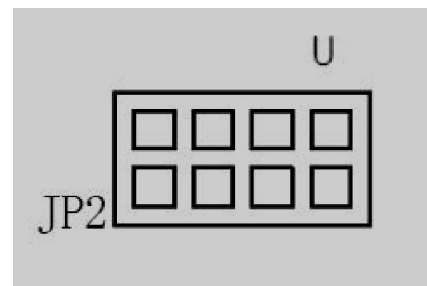

There are 2 lines 4 display in the scale of LCD; the first line is the analog output of selected range while the second line displays the selected unite. The detail of display can be got on the labels on the transmitter body. The model below shows the display of selected ranges and unites. For example, when the low range and English unit are selected, the full scale output is 20mA, display is 8000fpm; when low range and metric unit are selected, the analog output is 4mA; display is 40m/s.

FULL SCALE ANALOGUE OUTPUT

	L	M	H
English	600 fpm.	1200 fpm.	2400 fpm.
Metric	3 m/s	6 m/s	12 m/s

**NOTE: PLEASE DO NOT USE THE BLOCKS IN JP1 AND JP2 NOT METIONED IN THIS SECTOR, THEY ARE USED BY THE MANUFACTURERDURING THE PRODUCING PROCESS OR LEFT FOR THE FUTURE FUNCTION EXPENDATION. OR THE UNITE WILL NOT BE IN THE WARRANTY.**



## 8. CALIBRATION

See Figure below, the DPSENSE-V transmitters can be recalibrated by the user with two buttons marked “ZERO” and “SPAN”. There are four specifications that can be recalibrated: pressure input zero and pressure input span, analog output zero (0 V or 4 mA) and analog output full scale (10 V or 20 mA). The pressure and analog output are calibrated separately. These recalibrated values will be stored in nonvolatile memory without connection to external power or batteries. The factory calibration can be stored forever and restored easily. Four pieces of equipment are needed for recalibration: a stable pressure /different pressure source with the range exceeding the one under tested; a manometer or gauge is also needed except the case that it has been equipped together with the pressure /different pressure source. Additionally, a voltmeter/milliammeter with high accuracy is needed to test the analog output as well as a stable power source. The processes of recalibration are as follows.

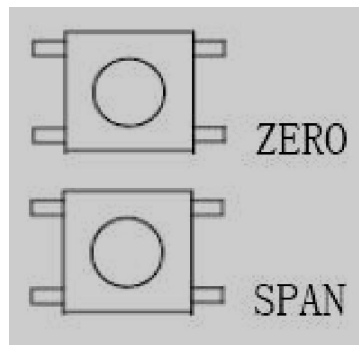

Calibration Buttons

### 8.1 Preparation

To connect the voltmeter / milliammeter and power supply to the transmitter is a correct way according the different connection ways of the transmitter (2-wire or 3-wire). Make sure that the polarities are connected in a right way. Please note that the transmitter should be in vertical position either in the calibration process or the process of usage and installation.

### 8.2 Analogue Zero Calibration

Connect the voltmeter or milliammeter to the output of the transmitter in a right way. Hold the “ZERO” button for 2-3 seconds, LCD will display:

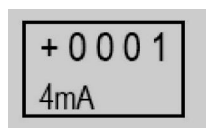

According to the different output selections, then the analog output should be 0V or 4 mA or near. Hold the buttons of “ZERO” and “SPAN” simultaneously and press them for down and up for 2 seconds or less until the value in the voltmeter or milliammeter reads 0.00V or 4.000 mA. Then Hold the buttons of “ZERO” and “SPAN” simultaneously again for 2 seconds or less, the reset reading is stored, the LCD displays:



Hold the button of “SPAN” for more than 4 seconds, and then the reading will recover to the normal value. The analog output reading now should show the right process value. The analog zero and full scale reset can be done separately or in different time, they also have nothing to do with the pressure source, because the analog zero and full scale calibrations are independent.

### 8.3 Analogue Span Calibration

Connect the voltmeter or milliammeter to the output of the transmitter in a right way. Hold the “ZERO” button for 2-3 seconds, LCD will display:

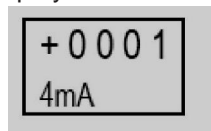

Hold the “ZERO” button again for 2-3 seconds, LCD displays:

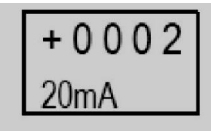

According to the different output selections, then the analog output should be 10V or 20 mA or near. Hold the buttons of “ZERO” and “SPAN” simultaneously and press them for down and up for 2 seconds or less until the value in the voltmeter or milliammeter reads 10.00V or 20.000 mA. Then Hold the buttons of “ZERO” and “SPAN” simultaneously again for 2 seconds or less, the reset reading is stored, the LCD displays:



Recover it to normal condition in the same way of zero calibration.

### 8.4 Filter Time Constant Adjustment

If the LCD is installed, the filter time constant of output can be adjusted by the user from 0.5-15 seconds in 1-second increments. This function is designed to reduce the noise produced by the unstable pressure in some noisy air. Under the normal operating condition, hold the “ZERO” button for 2-3 seconds, LCD displays:

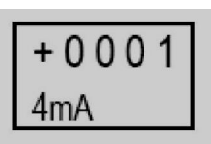

Hold the "ZERO" button for 2-3 seconds again and again, the LCD will display:

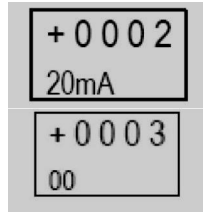

When the LCD display as below:

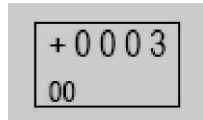

The filter time constant adjustment can be started. Press the button of either "ZERO" or "SPAN" quickly as the presses for down and up for less than 2 seconds. Do not stop until the Satisfactory time constant is setup (process can be displayed on the LCD). The bottom left will change from 0, 1 to 15 corresponding to the filter time constant from 0.5, 1 to 15 seconds. For example, if the constant is setup as 15 seconds, the LCD displays:

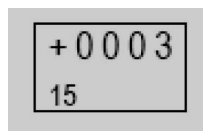

At this time, press the buttons of "ZERO" and "SPAN" simultaneously, do not stop for more than 2 seconds. Then the setup constant is stored and the LCD displays:

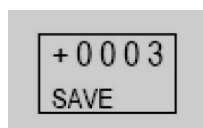

When the value returns to the formal one after 2 seconds, hold the button of "SPAN" for more than 4 seconds to recover the unit to the normal condition. The factory setup filter time constant is 2.0s.

## 8.5 Coefficient K Adjustment

If LCD displays that the module has been installed, then user can adjust the coefficient K, the range is 0.5-3.0 adjustable with the interval of 0.004. To adjust the K, under the normal condition; keep pressing "ZERO" for 2-3 seconds, LCD displays:

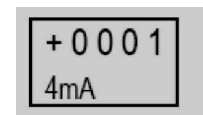

Repress "ZERO" for 2-3 seconds. It displays in turn:

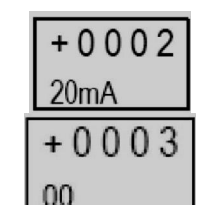

When it displays

1.000  
K

1.000  
K

It is the item for adjusting the K. Then press "ZERO" or "SPAN" shortly for not more than 2 seconds (at this time, they respectively equal to "DOWN" and "UP", means increase and reduce, then the K coefficient is set up (the process will be displayed on the LCD). The display data on the left bottom changes from 0.5 - 3.0, for example, if the K is set as 1.004, it displays:

1.004  
K

At this time, repress "ZERO" and "SPAN" at the same time for not more than 2 seconds, then the set time constant will be saved, LCD displays

+0004  
SAVE

It will come back to the primary display after about 2 seconds. Then, keep pressing "SPAN" for more than 4 seconds, then release it, at this time, the instrument has come back to the normal working condition.

## 8.6 Restore Factory Calibration

The factory calibration can be easily restored by the user no matter what the value is setup out of factory. Under the condition of transmitter working normally, hold the buttons of "ZERO" and "SPAN" simultaneously for about 5s. Then the factory calibration is restored and the all of the values setup by the user will be deleted. The second line of the LCD will display:

+10.23  
RESET

## 9. MAINTENANCE

It is suggested to recalibrate the transmitter once for each year. No special maintenances are needed there than keeping the exterior case and cover clean. If the repair is needed, send the transmitter back to our company.

### One Press Reset

When the micro-deviation of mounting causes the zero drifting, leave the two pressure adaptors in the air, press "ZERO" for more than 5 seconds, then the deviation will be cleared.

## 10. SAFETY PRECAUTIONS

---

1. The unit should be powered for 15 minutes before use for electronic devices.
2. Use in ambient temperature of 0-60°C.
3. Avoid vibrations, shock, excessive dust, corrosive chemical materials or gaseous environment.
4. Input wire should not be too long. If measured signal have to be far away from the unit, please use 2-core shielded cable.
5. Use this instrument in the scope of its specifications, otherwise fire or malfunctions may result.
6. Contact of the instrument, with organic solvents or oils should be avoided.
7. Do not turn on the power supply until all of the wiring is completed. Otherwise electrical shock, fire or malfunction may result.
8. Do not disassemble, repair or modify the instrument.
9. All connections should be tightened properly.
10. Power supply should be constant, should not be fluctuating.

## 11. WARRANTY

---

ABUS provides the original purchaser of this instrument a one (1) year warranty against defects in material and workmanship under the following terms:

- The one year warranty begins on the day of shipment as stated on the sales bill.
- During the warranty period all costs of material and labor will be free of charge provided that the instrument does not show any evidence of misuse.
- For maintenance, return the instrument with a copy of the sales bill to our factory.
- All transportation and insurance costs should be covered by the owner of the equipment.
- Should any sign of electrical or mechanical shock, abuse, bad handling or misuse be evident the warranty voids and maintenance costs will be charged.

REV01(051010)

- FrontPage Image Changed

**ABUS TECHNOLOGIES INC.**

www.abustek.com, E-Mail: info@abustek.com

---

ABUS TECHNOLOGIES INC.